

Article number: 0101054
 Description: Retaining ring A 37 DIN 471
 Spring steel
 Note: Fitted with ZGA pilers

Measures

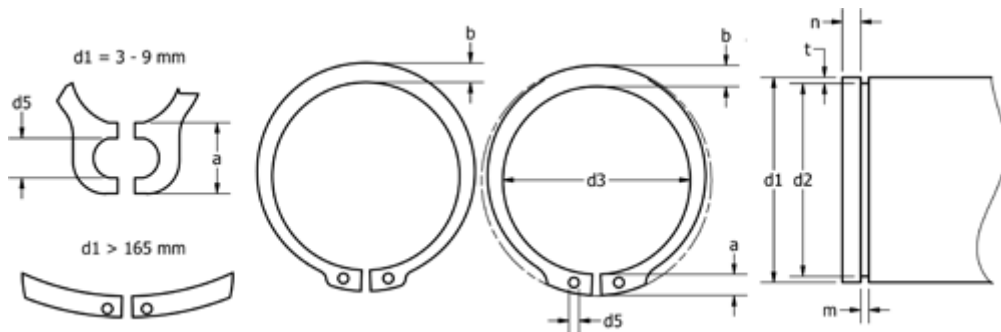

a max	= 5.7	FN kN	= 18.8	s	= 1.75
AN mm ²	= 113.0	FRg kN	= 9.15	t	= 1.00
b	= 4.1	FR kN	= 50.00	tol	= -0.25
d1	= 37	g	= 2.0	tol	= -0.06
d2	= 35.0	K kN-mm	= 96.40	tol	= +0,25-0,50
d3	= 34.2	m min	= 1.85	Tong	= ZGA-2
d5 min	= 2.5	n abl x 1000	= 14.0	Weight kg/1000	= 5.300
Description	= A37	Nominal drive	= 3.0		